

# White High-Intensity LED Lamp (5 mm, 50° Viewing Angle)

## OVLEW5CB6

- Wide beam angle
- High luminous intensity
- Blue LED + yellow phosphor
- ESD protected ( $\pm 1\text{kV}$ , 1 time, [200pF 0 $\Omega$ ])

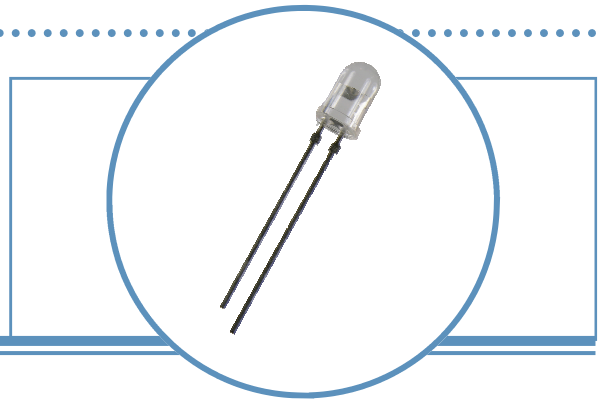

The **OVLEW5CB6** is a round 5 mm white high-intensity lamp with a 50° viewing angle and stand-offs. It is designed for applications that require high luminous intensity, such as indoor and outdoor displays, marker lights and optical indicators.

### Applications

- Indoor/outdoor displays and applications
- Message boards
- Store front signage
- Indicators

Part Number	Material	Emitted Color	Intensity Typ. mcd	Lens Color
OVLEW5CB6	InGaN	White	1600	Water Clear

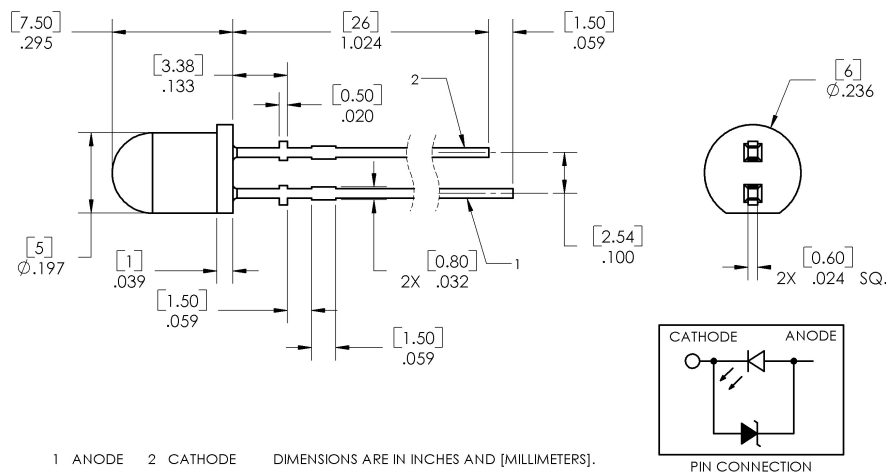

**DO NOT LOOK DIRECTLY AT LED WITH UNSHIELDED EYES OR DAMAGE TO RETINA MAY OCCUR.**

OPTEK reserves the right to make changes at any time in order to improve design and to supply the best product possible.

### Absolute Maximum Ratings

T<sub>A</sub> = 25° C (on metal core PCB) unless otherwise noted

Storage Temperature Range	-40 ~ +100 °C
Operating Temperature Range	-30 ~ +85 °C
Reverse Current	100 mA <sup>Δ</sup>
Continuous Forward Current	30 mA
Forward Current Reduction	-0.50 mA/°C
Power Dissipation	120 mW

Note:

1. <sup>Δ</sup> = Zener Diode Rating.

### Electrical Characteristics

T<sub>A</sub> = 25° C (on metal core PCB) unless otherwise noted

SYMBOL	PARAMETER	MIN	TYP	MAX	UNITS	CONDITIONS
I <sub>V</sub>	Luminous Intensity	900	1600	2600	mcd	I <sub>F</sub> = 20 mA
V <sub>F</sub>	Forward Voltage	2.8	3.4	3.9	V	I <sub>F</sub> = 20 mA
V <sub>R</sub>	Reverse Voltage	----	----	2.5	V	I <sub>R</sub> = 10 mA
2 Θ <sub>1/2</sub>	50% Power Angle	----	50	----	deg	I <sub>F</sub> = 20 mA
x	Chromaticity Coordinates	----	0.310	----	----	I <sub>F</sub> = 20 mA
y		----	0.320	----	----	I <sub>F</sub> = 20 mA

### Standard Bins (I<sub>F</sub> = 20 mA)

Lamps are sorted to luminous flux (Φ<sub>v</sub>) and chromaticity coordinates (x, y) bins shown. Orders for OVLEW5CB6 may be filled with any or all bins contained as below.

	<b>A0</b>	<b>B3</b>	<b>B4</b>	<b>B5</b>	<b>B6</b>	<b>C0</b>	
Luminous Intensity (mcd)	<b>1800-2600</b>						<b>6</b>
	<b>1300-1800</b>						<b>5</b>
	<b>900-1300</b>						<b>4</b>

Luminous Intensity is at 4 bin or above.

Chromaticity Coordinates (x, y)

Rank		A0				B3				B4			
Chromaticity Coordinates	x	0.280	0.296	0.283	0.264	0.287	0.307	0.304	0.283	0.307	0.330	0.330	0.304
	y	0.248	0.276	0.305	0.267	0.295	0.315	0.330	0.305	0.315	0.339	0.360	0.330

Rank		B5				B6				C0			
Chromaticity Coordinates	x	0.296	0.311	0.307	0.287	0.311	0.330	0.330	0.307	0.330	0.356	0.361	0.330
	y	0.276	0.294	0.315	0.295	0.294	0.318	0.339	0.315	0.318	0.351	0.385	0.360

Notes:

- All ranks will be included per delivery, rank ratio will be based on the chip distribution.
- Pb content <1000 PPM.
- To designate luminous intensity ranks, please contact OPTEK.

OPTEK reserves the right to make changes at any time in order to improve design and to supply the best product possible.

CIE Chromaticity Diagram

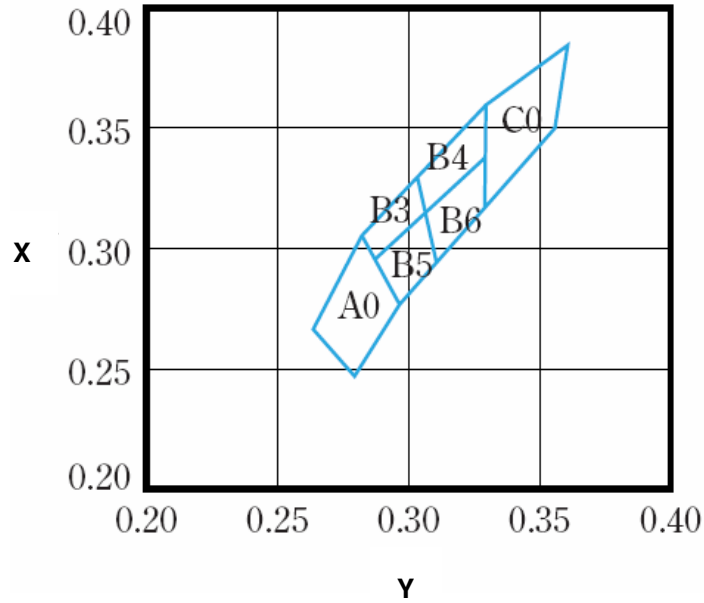

Beam Pattern

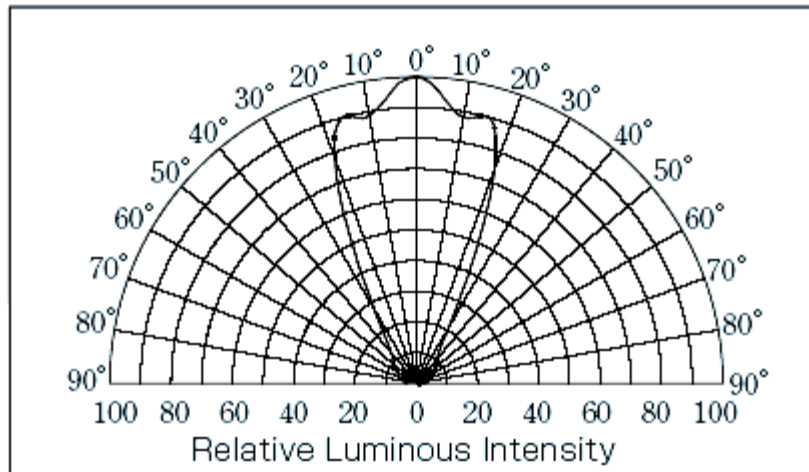

OPTEK reserves the right to make changes at any time in order to improve design and to supply the best product possible.

### Typical Electro-Optical Characteristics Curves

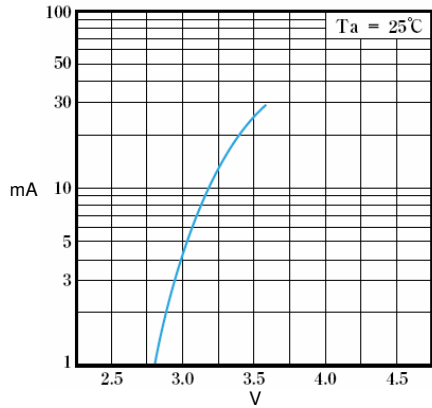

Forward Current vs Forward Voltage

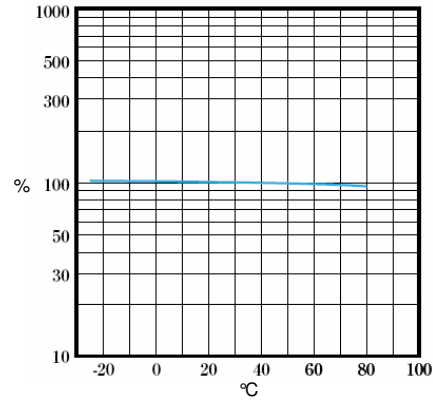

Relative Luminous Intensity vs Ambient Temperature

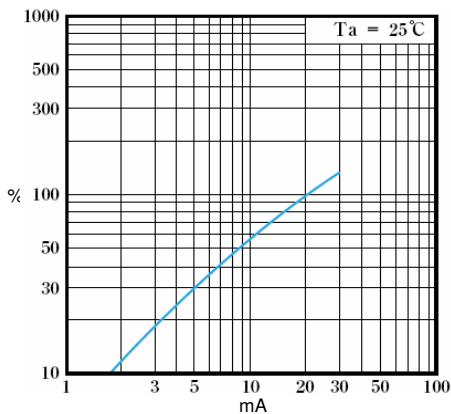

Relative Luminous Intensity vs Forward Current

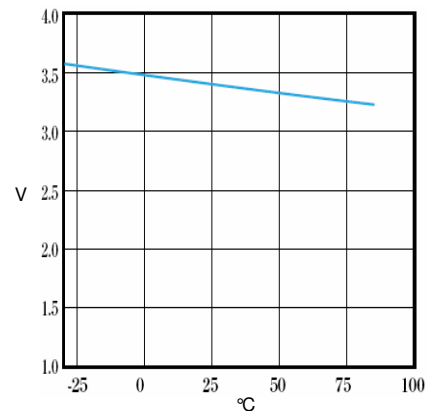

Forward Voltage vs Ambient Temperature

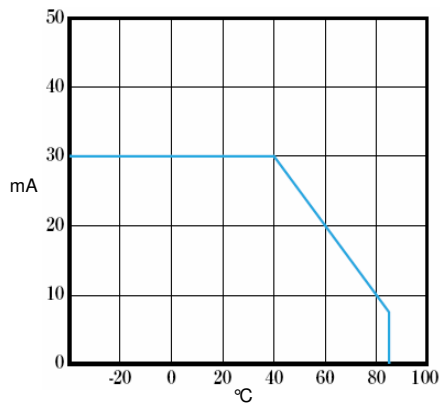

Forward Current vs Ambient Temperature

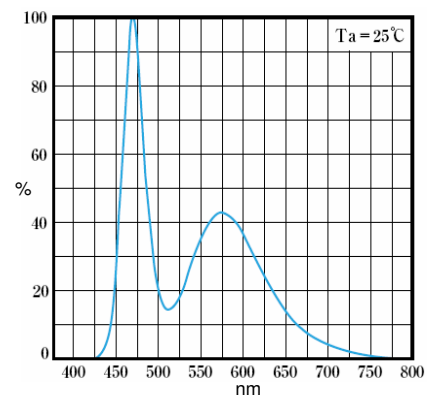

Relative Luminous Intensity vs Wavelength

OPTEK reserves the right to make changes at any time in order to improve design and to supply the best product possible.

Packing Information: Available in bulk or reel

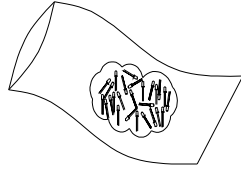

Bulk: 200 pcs/  
ESD-protected bag

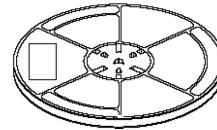

13-inch reel: 2000 pcs/reel

Carrier Tape Dimensions: Loaded quantity 2000 pieces per reel

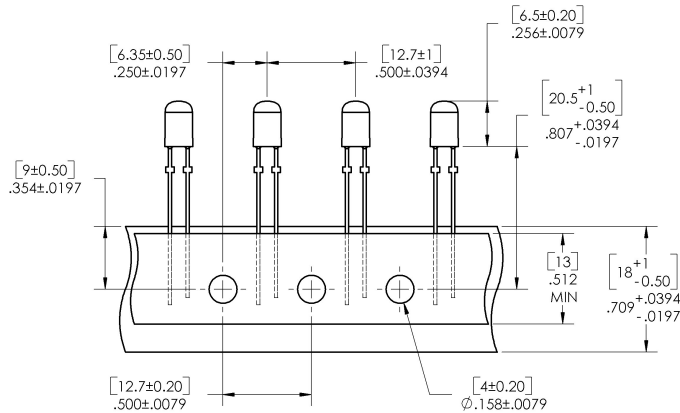

### Moisture Resistant Packaging

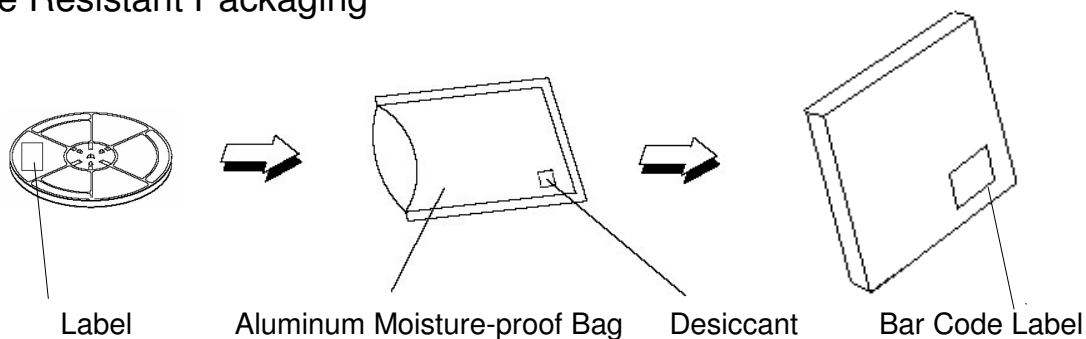

OPTEK reserves the right to make changes at any time in order to improve design and to supply the best product possible.